

# **Military Life**



OPERATION DESERT STORM

*Persian Gulf*

1991





# Kobar Towers







# Road to the KKMC







# 350<sup>th</sup> Evacuation Hospital

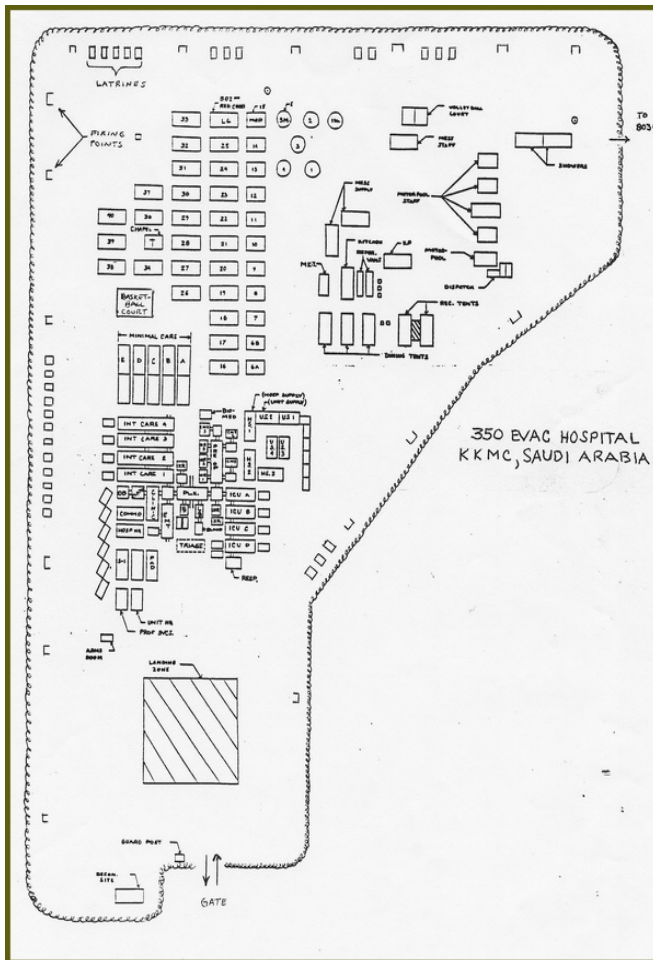

# Deployable Medical System

BOX SHIPPING  
(MILVAN)

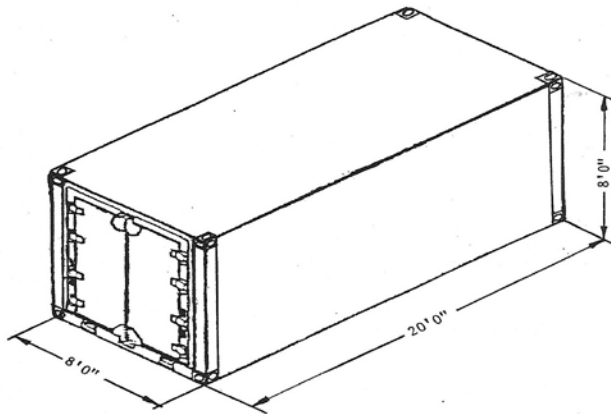

Empty Weight 5758 lbs  
Interior: L 19'1"  
W 7'8"  
H 7'2"  
Interior cubic ft 1047

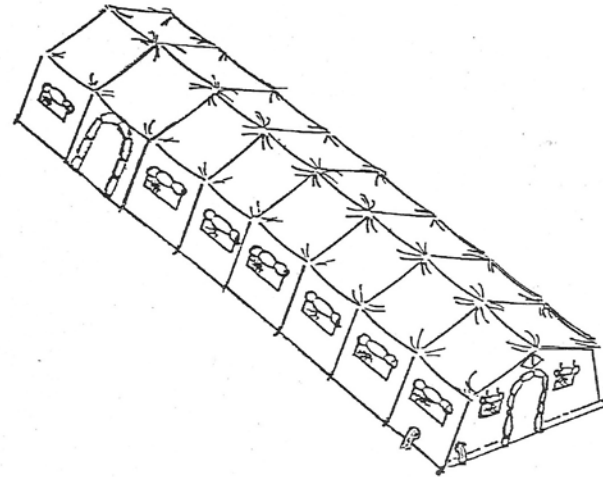

Storage volume 316.4' cube  
Weight 3639 lbs  
# doorways: 4  
# vestibules: 3  
Color code Green

EIGHT SECTION TEMPER, 64 x 20, MEDICAL

# Construction



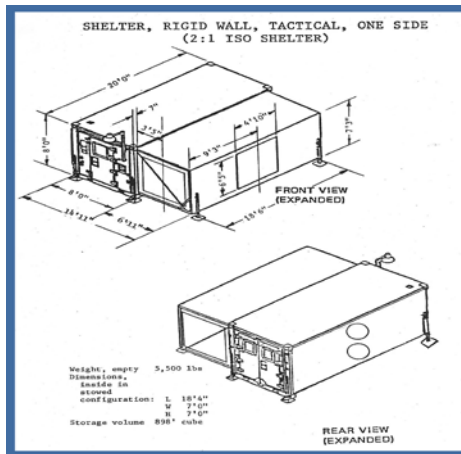

### FUNCTIONS IN 2:1 ISO SHELTER

- X-RAY
- PHARMACY
- CENTRAL MATERIAL SERVICE

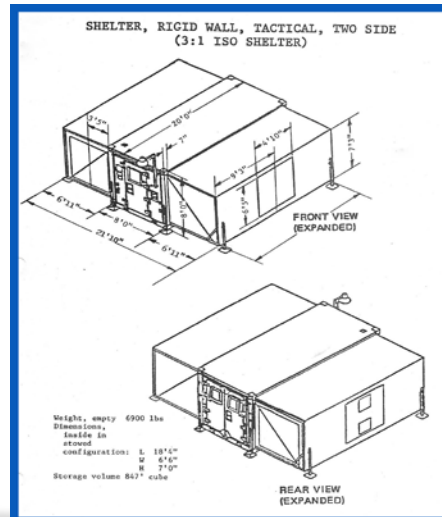

### FUNCTIONS IN 3:1 ISO SHELTER

- OPERATING ROOM
- GENERAL LABORATORY
- BLOOD BANK
- MEDICAL MAINTENANCE

# 400 Bed Hospital





# Head Quarters





# Laundry

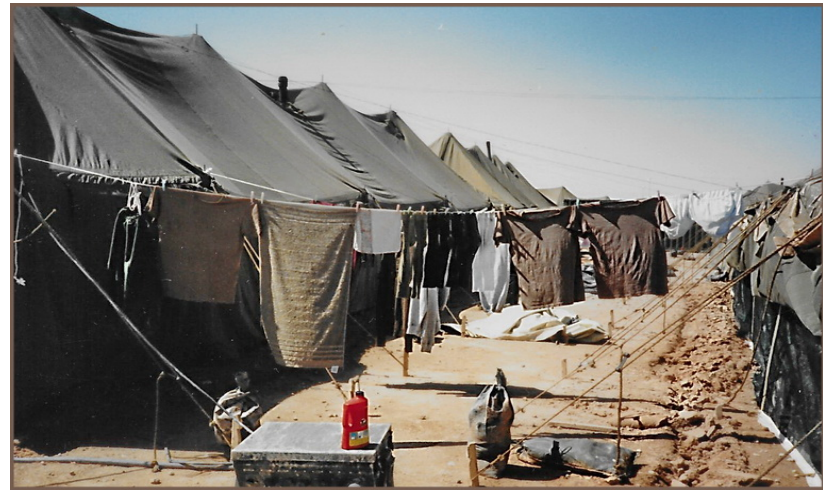

# Latrine



# Living Quarters



# Communication

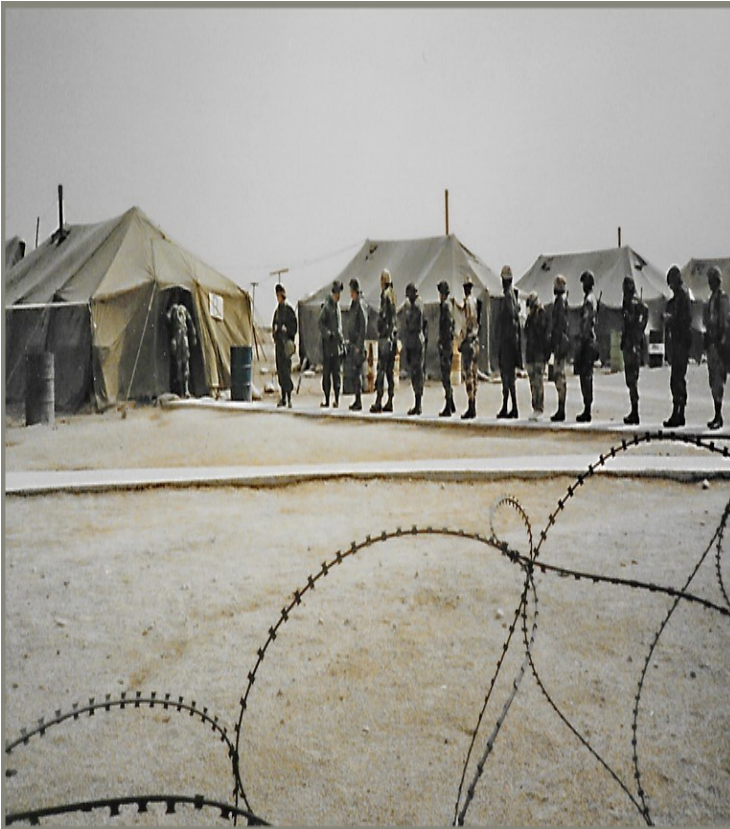

- ⦿ **Phone home**
- ⦿ **Red Cross**
- ⦿ **Orders**
- ⦿ **Lack of.....**

# Activities of Daily Living

- **Latrine**
- **Brush Teeth**
- **Laundry**
- **Lack of creature comforts**
- **Meals**
- **Shower**
- **Communication**

# Hospital Statistics

- ◎ **Sick call and clinic = 3174**
- ◎ **Redeployment physicals = 5328**
- ◎ **Admissions = 988**
- ◎ **Operating room = 189**
- ◎ **Emergency room = 3039**
- ◎ **EPW camp**
- ◎ **Maintain health and welfare of troops**

# Patient Care



# Patient Care





# Environment



- ◎ Heat
- ◎ Cold





# Stressors

- ⦿ **Activities of daily living**
- ⦿ **Fear of the unknown**
- ⦿ **Orders**
- ⦿ **Harassment**
- ⦿ **Family**
- ⦿ **Work conditions**
- ⦿ **Extreme weather conditions**
- ⦿ **Communication**
- ⦿ **Work load**
- ⦿ **Generator noise**
- ⦿ **Lack of exercise**
- ⦿ **Cultural difference**



# Mosque



# Combat Stress

- Mail
- Big Red #1 Band
- No question tent
- Chaplains
- Occasional social



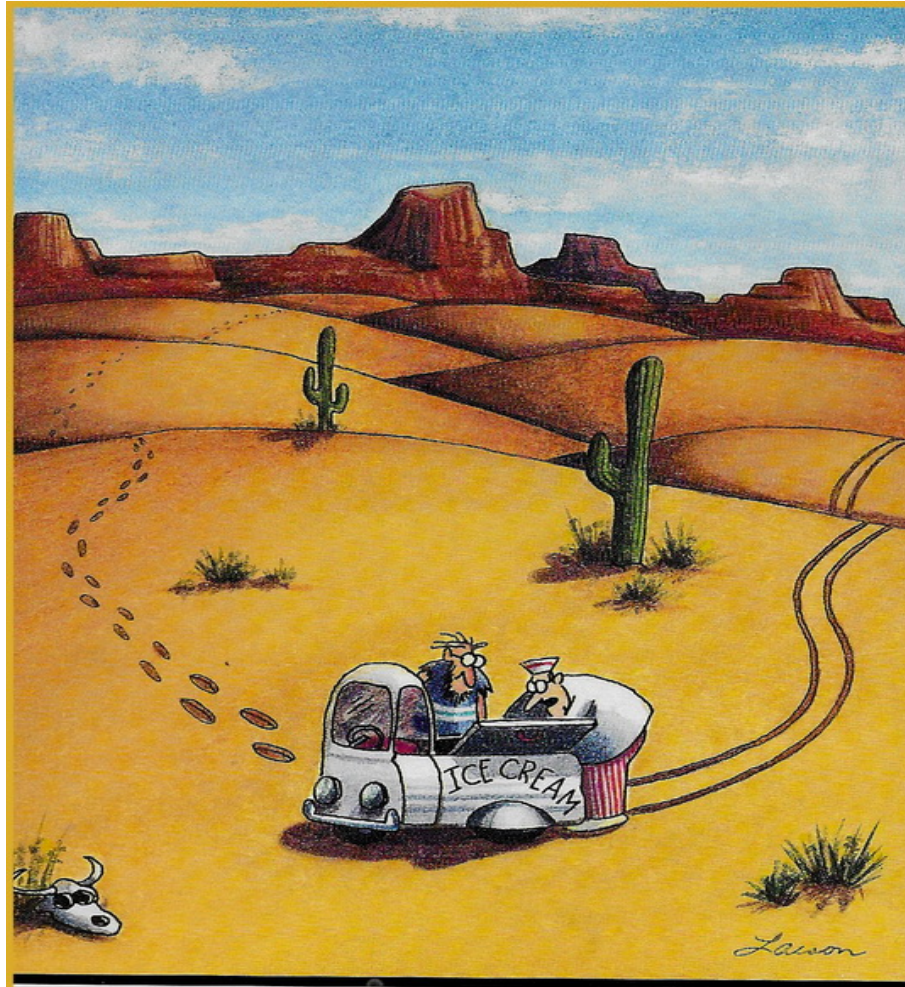

**"Let's see...no orange...no root beer...  
no Fudgsicles.... Well, for crying-out-loud!  
Am I out of everything?"**

# Local Shopping



# Saudi Riyal



- The Saudi Riyal is the basic monetary unit. Consists of 100 halalahs and is issued in notes and



# The Kingdom of Saudi Arabia



- The official emblem of the Kingdom of Saudi Arabia is a date palm and crossed swords. The date palm represents vitality and

# Mission Accomplished



# KKMC Hospital



# Home

- **Family Dynamics**
- **Fraternization**
- **Profession**
- **Physical Health**
- **Mental Health**

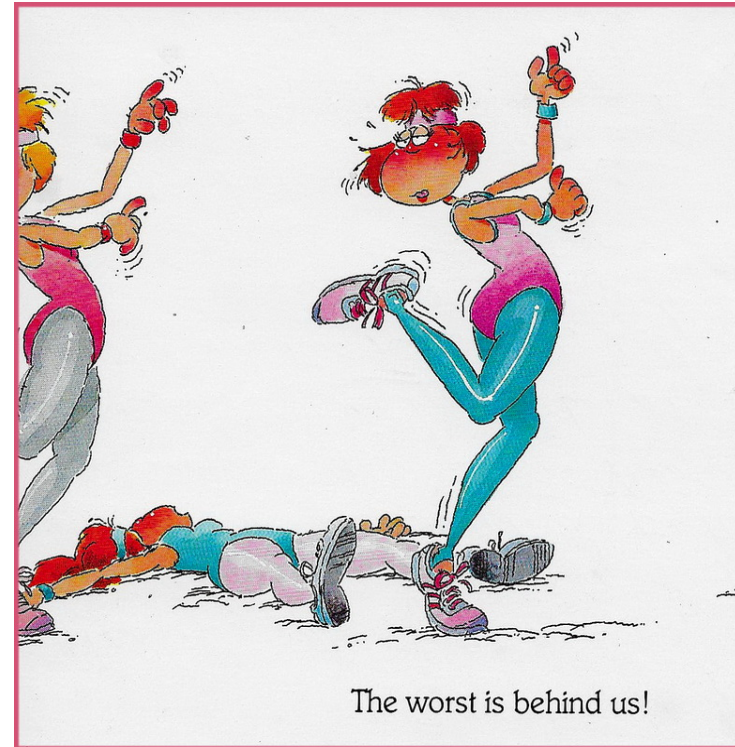

# Southwest Asia Service Medal

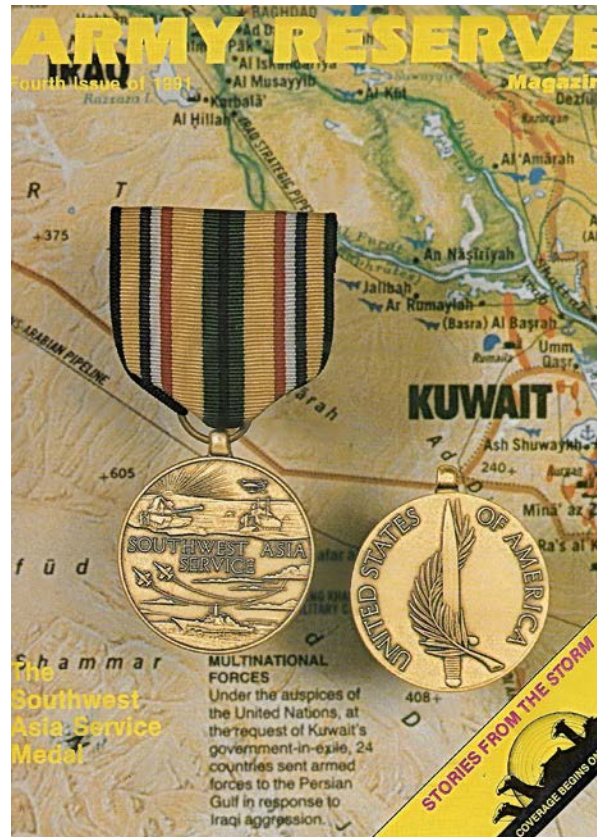

To Major Nagy  
Carolyn

Because of your contribution to the  
war effort we got to Kuwait  
and liberated the people.

Much thanks to the 350th for all the  
help.

Gen Schwarzkopf & Maj Bates

3 Mar 91  
Kuwait City



# Statistics

- **Vietnam War**

- 265,00 women volunteers

- 11,000 were

- nurses **Gulf War**

- 40,000 women

- 8 military women lost

- 11 killed in action their life

- 2 POW

- 1993 all armed services opened to women

- **War in Iraq**

- Since March 2003 more than 70 women were killed and 400



**Women  
Veteran's  
Initiative**



# Today's Issues:

- Stress fractures
- Sexual harassment
- Privacy
- Expand peer to peer counseling, group counseling and call centers
- Eliminate barriers to care by increasing number of gender specific providers
- Improve environment for women veterans
- Legal assistance
- Improve collection and analysis data
- Sustain campaign to prevent combat suicide
- Benefits

# ODVS Director



- Maj. Gen. Deborah Ashenhurst (U.S. Army, retired)
- Ohio National Guard for 37 years
- Served 4 years as the Adjutant General and Commander of the State of Ohio
- Appointed by Governor DeWine. First female ODVS Director and the fifth director since inception in 2008